



# ROOTS® Meters & Instruments

## DATA SHEET

### SERIES B3: 3MI75 ROOTS® Meter

	UNITS Imperial	UNITS Metric
Temperature Range	deg. F -40 to +140	deg. C -40 to +60
Base Rating (Q Max.)	acfh 3000	m <sup>3</sup> /h 85
Max. Operating Pressure (MAOP)	psig 175	kPa 1200
Leak Test (125% MAOP)	psig 219	kPa 1510
Static Test (2 x MAOP)	psig 350	kPa 2400
Rangeability +/- 1%	ratio 76:1	ratio 76:1
Rangeability +/- 2%	ratio 139:1	ratio 139:1
Start Rate	cfh 2.1	m <sup>3</sup> /h 0,0595
Stop Rate	cfh 1.8	m <sup>3</sup> /h 0,0510
Flow Rate @ 0.5" w.c., Gas	cfh 2580	m <sup>3</sup> /h 73,1
Avg. Differential, 100% Flow	in. w.c. 1.1	mbar 2,6
Max. Pressurization Rate	psig/sec 5	kPa/sec 35
Max. Operating Speed	rpm 2000	rpm 2000
Gear Ratio	ratio 400:1	ratio 141,1764:1
Displaced Volume/Revolution	cf 0.025	m <sup>3</sup> 0,000708
Drive Rate, CD	cf/rev 10	m <sup>3</sup> /rev 0,1
Drive Rate, TD	cf/rev 100	m <sup>3</sup> /rev 1
Temp. Compensating Range (TC,TD)	deg. F -20 to +120	deg. C -29 to +49
Min. Odometer Reading	cf 0.2	m <sup>3</sup> 0,002
Odometer Turnover	yrs. 3.8	yrs. 1,34
Nominal Pipe Size	in. 2	mm 50,8
Flange-to-Flange	in. 6-3/4	mm 172
Flange Connection	ANSI 125#FF	ANSI 125#FF
Bolts per Flange	qty. 4	qty. 4
Bolt Size <sup>1</sup>	in. 5/8 - 11	in. 5/8 - 11
Flange Bolt Hole Depth	in. 15/16	mm 23,8
Bolt Torque: Lubricated/Non-Lub.	ft.-lb. 55/60	N-m 74/81
Restricting Orifice (120%)	in. 17/32	mm 9,525
Oil Capacity – Side Inlet	oz. 1.25	ml 37
Oil Capacity – Top Inlet	oz. 7.65	ml 226
<i>Counter Version (CTR)<sup>2</sup></i>		
Net Weight	lbs. 29	kg 13,2
Shipping Weight	lbs. 31	kg 14,1
Carton Size	in. 27 x 11 x 9	cm 69 x 28 x 23
<i>Counter with Instrument Drive (CD)<sup>2</sup></i>		
Net Weight	lbs. 33	kg 15,0
Shipping Weight	lbs. 38	kg 17,2
Carton Size	in. 31 x 15 x 13	cm 79 x 38 x 33

NOTES:

<sup>1</sup> Bolt Length varies by application.

<sup>2</sup> Weights and dimensions available for CPS, TC, TD, TPS upon request.

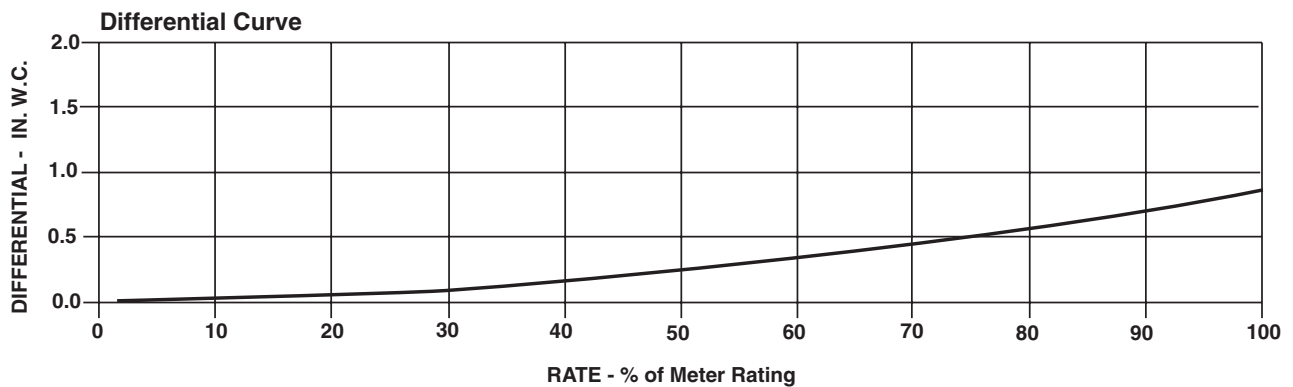
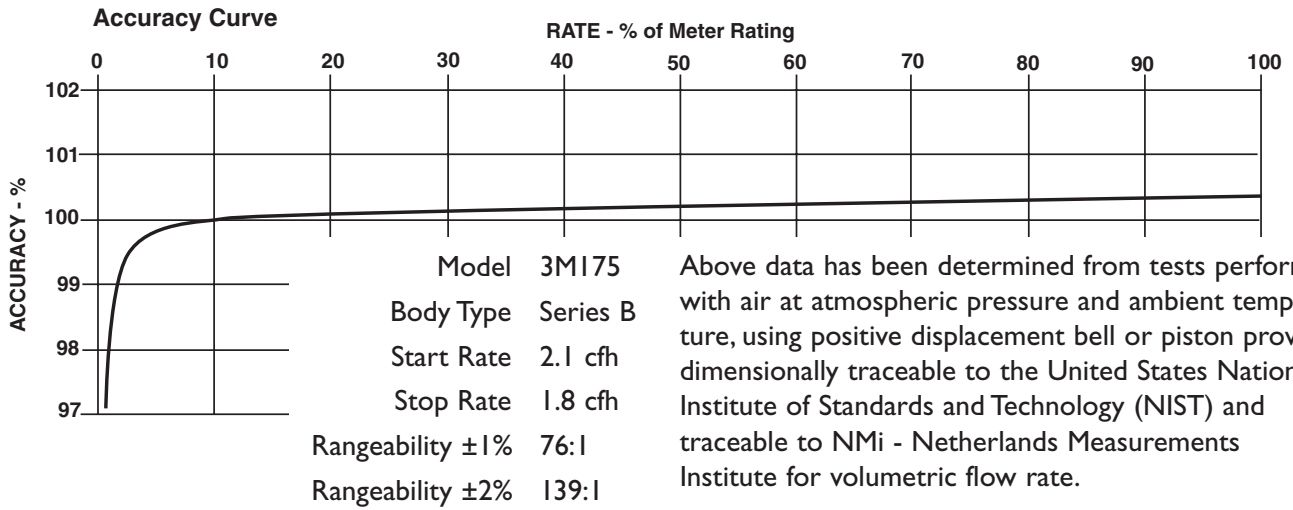

3M175 Series B3	Overall Length		Overall Height		Width (Flange/Flange)		Centerline to Accessory End (CL-AU)		Request Detailed Drawing Number
	inches	mm	inches	mm	inches	mm	inches	mm	
CTR / TC	17-1/8	435	6-31/32	177	6-3/4	172	10-7/8	276	D054517-000
CD / TD	20-31/32	533	6-31/32	177	6-3/4	172	14-23/32	374	D054431-000
CPS / TPS	9-1/4	489	6-31/32	177	6-3/4	172	13	330	D054670-000
IMC/C	20-5/8	524	6-31/32	177	6-3/4	172	14-3/8	365	D056486-000
IMC/W	21-5/8	549	6-31/32	177	6-3/4	172	15-3/8	391	D056702-000

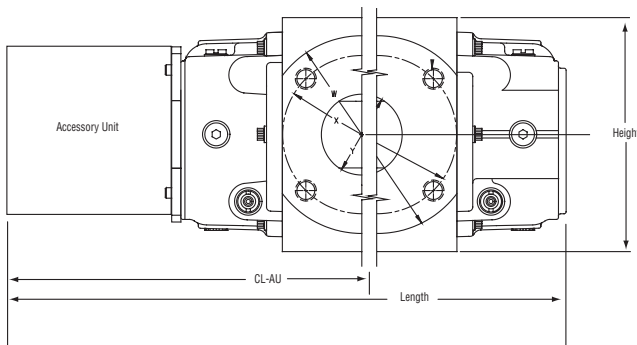

**To order**

Specify: Meter Series, Size and Type (i.e., ROOTS Meter Series B3 3M175 CD).  
 For CD or TD, specify Inlet (Top or Side) and ID Rotation (CW-B or CCW-A).  
 For Pulsar, specify Single or Dual Connectors and Connector Type (MS Circular, Conduit or Cable Gland).  
 For more specific ordering information on the electronic products, request: TS:SSP, TS:IMC/C or S:IMC/W.  
 Contact the factory for other available information, options, or special requests.



**Dresser Roots Meters & Instruments**

P. O. Box 42176  
 Houston, TX USA 77242-2716  
 website: www.dresser.com

**Dresser, Inc.**

Inside US Ph: 800.521.1114 Fax: 800.335.5224  
 Outside US Ph: 281.966.4300 Fax: 281.966.4308  
 www.rootsmeters.com